

SKU: CWC1ADA

Cabinet

08/10/22

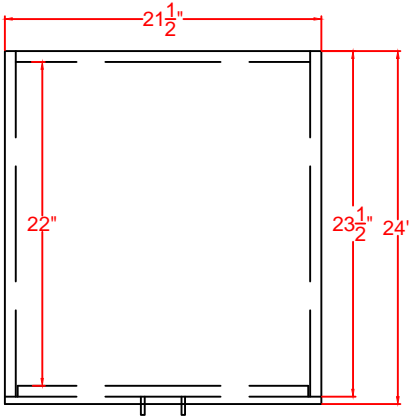

Plan

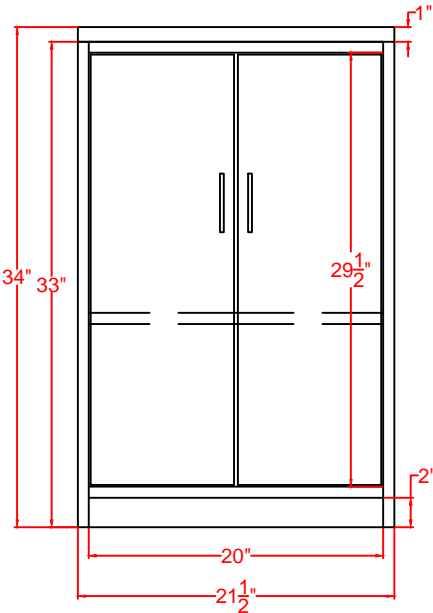

Elev

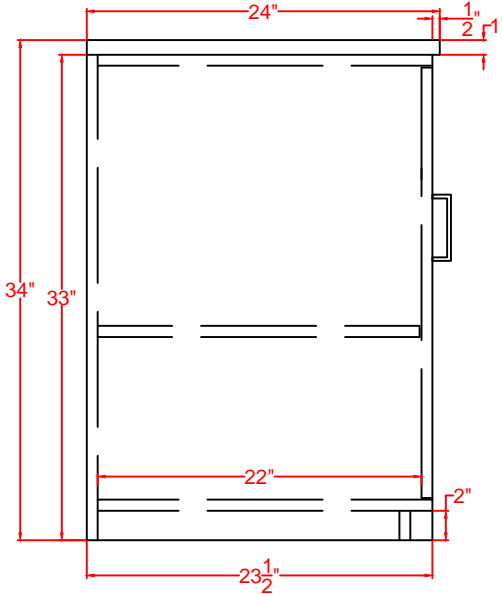

Profile

SUMMIT

FELIX STORCH, INC.
www.summitappliance.com

718-893-3900